

ZESTAWIENIE ROZSTAWU PODPÓR DLA CARPORTÓW

R 1

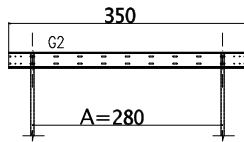

R 2

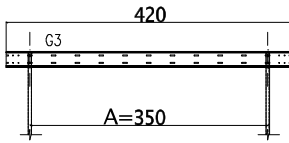

R 3

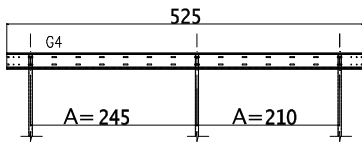

R 4

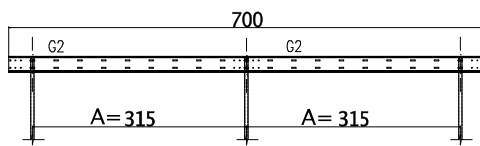

R 5

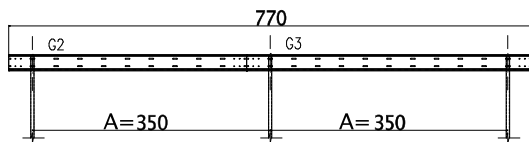

R 6

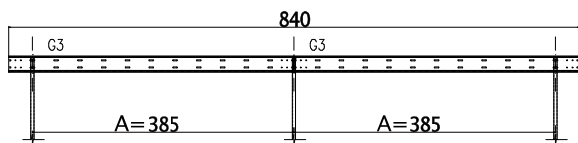

R 7

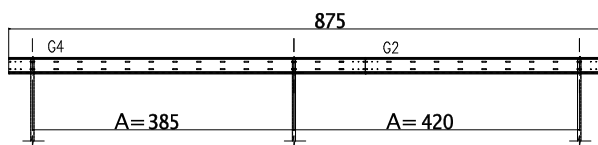

R 8

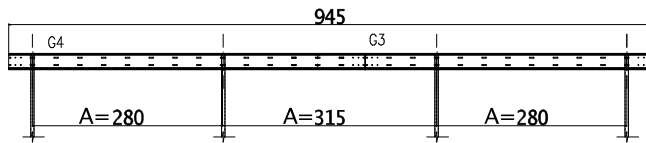

R 9

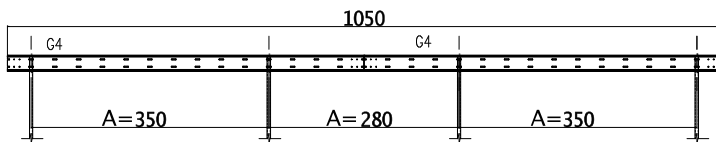

R 10

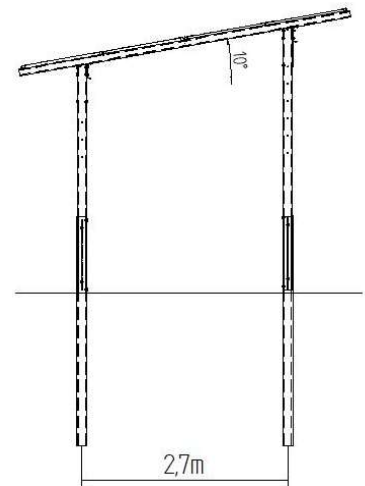
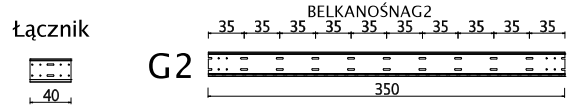
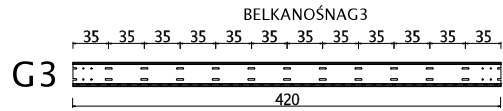
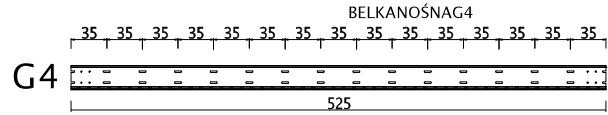
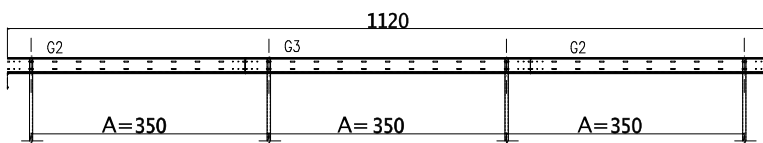

Carporty 4-modułowe

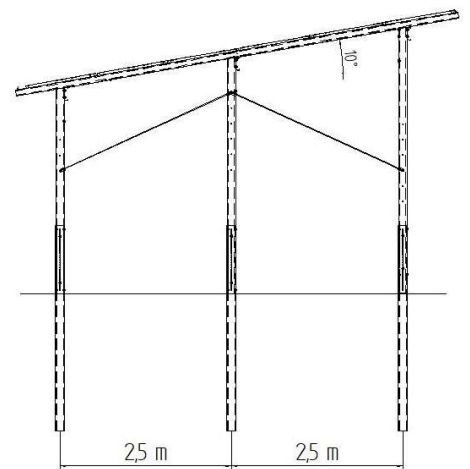

Carporty 5- i 6-modułowe

ZESTAWIENIE ROZSTAWU PODPÓR DLA CARPORTÓW

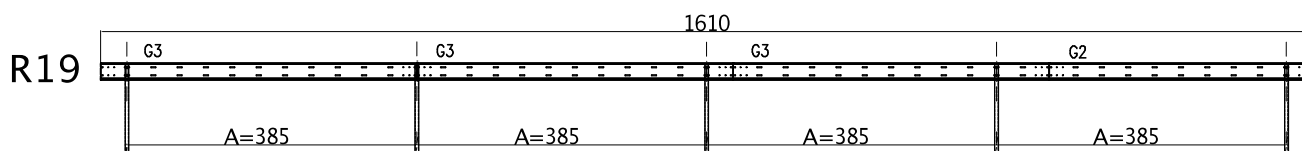
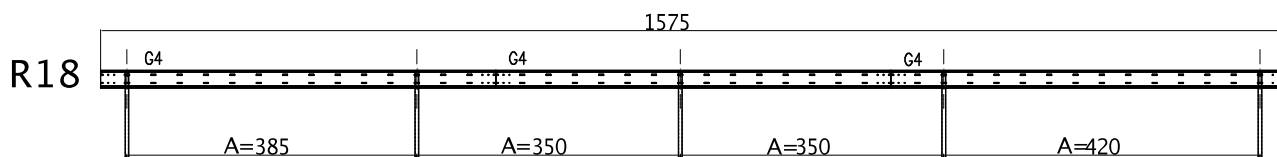
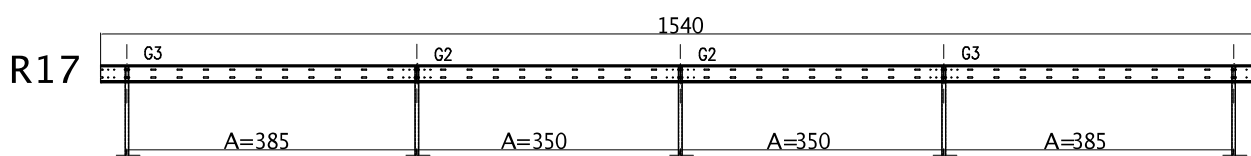
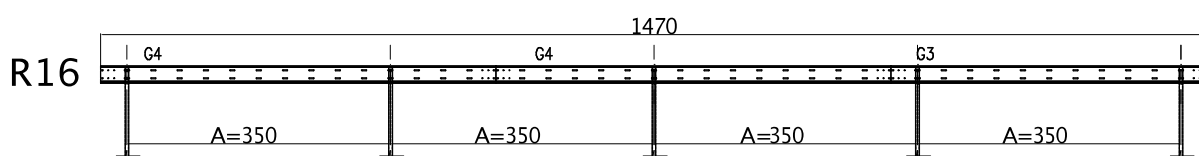
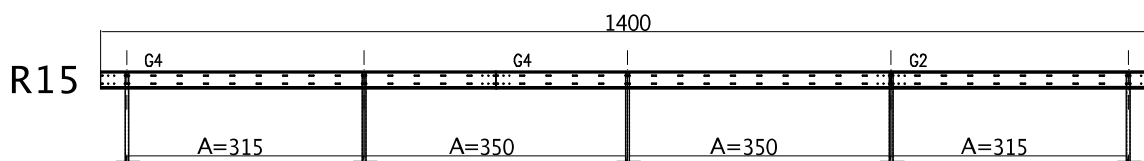
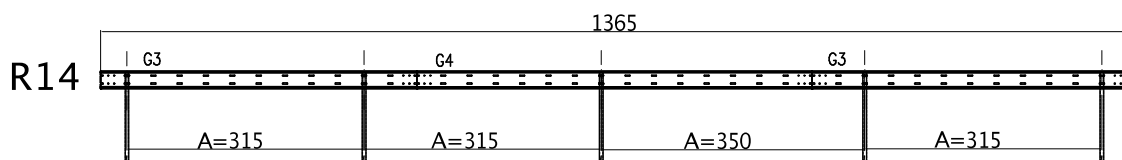
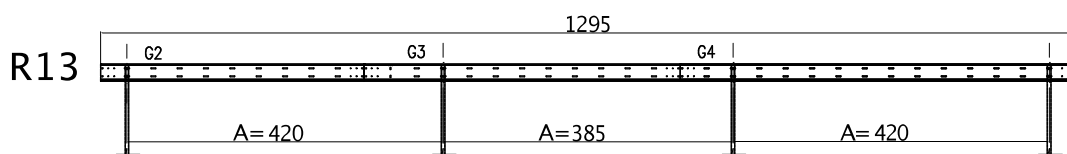
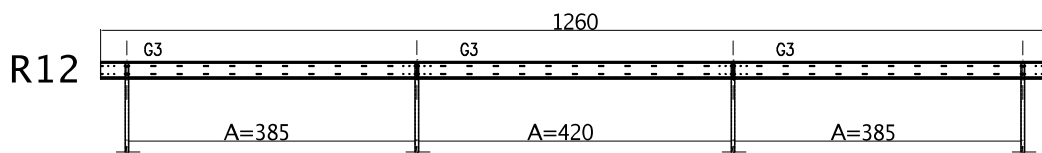
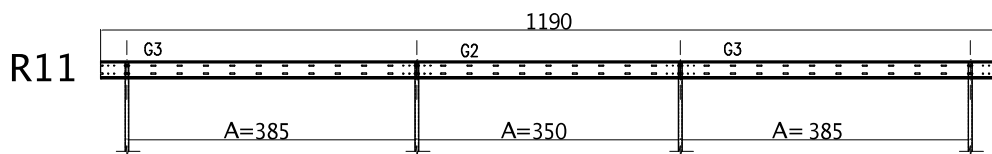

ZESTAWIENIE ROZSTAWU PODPÓR DLA CARPORTÓW

